



Mezzanine

Innovative industrial floor panels



Unistor Global Pty Ltd
1300 137 220
sales@unistor.com.au
www.unistor.com.au

Who is UNILIN?

UNILIN, division panels, an international player

UNILIN, division panels is part of the UNILIN Group, itself a subsidiary of the stock exchange listed company MOHAWK Industries Inc., the largest flooring company in the world.



Our circular thought

To support our growth over the years, we are always on the lookout for sustainable materials and invest in our own biomass systems.



LOCAL WOOD

We use only wood sourced from locations within a 400 km radius of the production sites. This local import of wood is the result of partnerships with recycling yards, demolition firms, the packaging industry and even our own customers.

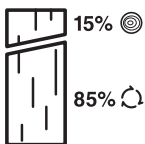

100% CIRCULAR WOOD

Thanks to high-tech selection and sorting processes, we are able to ensure that our Mezzanine floor panels are made from up to 85% recycled wood, supplemented by wood from waste streams of the timber industry, sustainable forestry and roadside maintenance.



WOOD AS A SOURCE OF ENERGY

Wood and residues which are not suitable for the production of panels are used to produce heat for our production plants or to generate green energy in our biomass systems. Our goal is always to ensure that none of this natural resource goes to waste.

Mezzanine product overview

Finishes

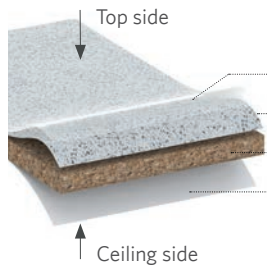

Fire protection	Top side	Ceiling side
🔥🔥🔥 Outstanding	B _{fl} -s1	B-s1,d0
🔥🔥 Average	C _{fl} -s1	C-s1,d0
🔥 Minimal	D _{fl} -s1	D-s2,d0

	Top side	Anti-slip	Ceiling side	
Standard	Untreated/Raw		Untreated/Raw	
Mezzanine Standard	🔥🔥	n.a.	🔥	P. 4
White	Untreated/Raw		Clear white	
Mezzanine White	🔥🔥	n.a.	🔥	P. 5
Deluxe	Wear-resistant and anti-static		Clear white	
Mezzanine Deluxe	🔥🔥	R10	🔥	P. 6
Mezzanine Supreme Deluxe	🔥🔥🔥	R10	🔥	P. 7
Flameshield Deluxe (C-class)	🔥🔥	R10	🔥🔥	P. 7
Flameshield Supreme Deluxe (B-class)	🔥🔥🔥	R10	🔥🔥🔥	P. 7
Antislip	Wear-resistant, anti-static and highly anti-slip		Clear white	
Mezzanine Antislip	🔥🔥	R12	🔥	P. 8
Mezzanine Supreme Antislip	🔥🔥🔥	R12	🔥	P. 9
Flameshield Antislip (C-class)	🔥🔥	R12	🔥🔥	P. 9
Flameshield Supreme Antislip (B-class)	🔥🔥🔥	R12	🔥🔥🔥	P. 9

Base boards

- Chipboard U7 - extremely strong and rigid, CE class P6
- Chipboard P5 - structural and moisture-resistant
- Chipboard P4 - basic quality

The specified fire reaction classes are based on base board U7. The results may vary for base boards P4 or P5. The full range of CE-certified fire results can be obtained via your sales representative or by e-mailing info.panels@unilin.com.



Innovative industrial floor panels

Properties

Discover our Mezzanine product range, high-performance structural panels with unique properties:



High load-bearing capacity



Fire retardant



Fast installation



Anti-slip



Ergonomic sizing



Durable and wear-resistant



100% circular wood



Anti-static



CE-certified



Moisture-resistant

Distributed by  unistor

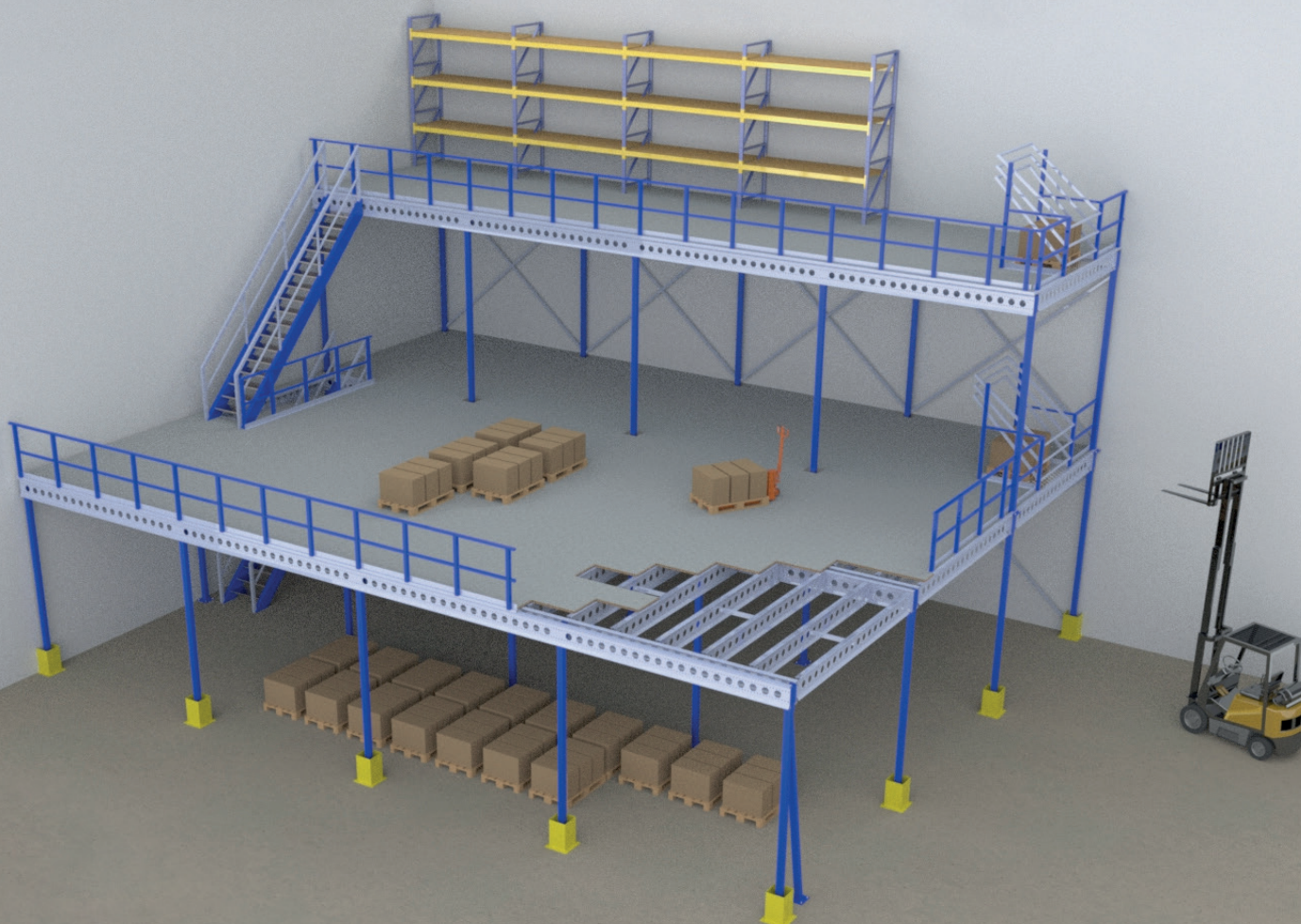

Mezzanine product range

Mezzanine Standard



Top side: untreated/raw
Ceiling side: untreated/raw

Designed especially for mezzanine floors, the exceptionally strong U7 base panel has been developed with a high density and strongly bonded outer layers. This allows for higher loadings or

greater spacing between the supports. A leaner substructure, including greater beam spacing and omission of distribution sheet plates, means that mezzanine floors can be installed much more cost efficiently.

PROPERTIES



U7 - extremely strong and rigid

- High point loads
- Limited deflection
- Cost-efficient
- Chipboard class P6



Ergonomic sizing



100% circular wood



CE-certified



Tongue and groove on 4 sides

Mezzanine White

Distributed by  unistor



Top side: untreated/raw
Ceiling side: clear white

By giving the floor panel a white finish on the ceiling side, light reflection is enhanced, helping to create a brighter space. This can help to reduce the light intensity or spacing

between lights to reduce energy consumption. The ceiling side can be cleaned easily with a slightly damp cloth.

PROPERTIES



U7 bearing capacity



A brighter space



Tongue and groove on 4 sides



Mezzanine Deluxe

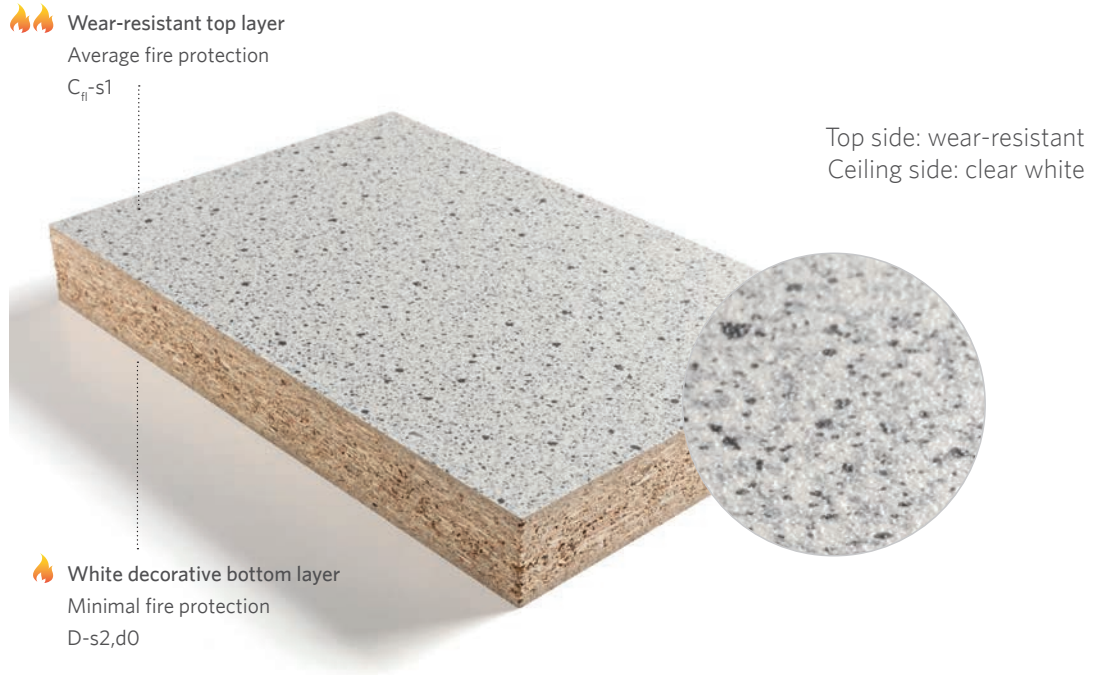

Mezzanine Deluxe panels are equipped with a decorative, wear-resistant finish on the top side, complete with a slip-resistant surface structure (R10).

By giving the ceiling side a white decorative finish, light reflection is enhanced, helping to create a brighter space.

PROPERTIES



Anti-slip R10



Average fire-retardant
top side C_{fi} -s1



Wear-resistant AC4



Tongue and groove on 4 sides



A brighter space



Anti-static



U7 bearing capacity

FIRE-RETARDANT VERSIONS OF DELUXE

For fire safety, the Mezzanine Deluxe can be upgraded with fire-retardant solutions to help extend evacuation times by reducing the spread of fire and limiting the development of smoke. You can find further information on fire safety on [page 10](#).

Mezzanine Supreme Deluxe

B_{fi}-s1

Fitting a fire-retardant, wear-resistant layer to the top side improves the fire reaction class from C_{fi}-s1 to B_{fi}-s1, which is the best fire reaction available for wooden floors.



Flameshield Deluxe

C-CLASS

By melamine coating a white fire-retardant layer to the bottom side during the production process, the fire reaction on the ceiling side can be improved from class D to class C and the sensitivity of the product to damage during installation and transport can be reduced.



Flameshield Supreme Deluxe

B-CLASS

A fire-retardant, wear-resistant top layer and a white, highly fire-retardant underlayer on the bottom side are combined to create a fire-retardant B-class mezzanine floor panel.



* Fire reaction class C-s1,d0/B-s1,d0 applicable to base boards P4 and U7, C-s2,d0/B-s2,d0 to base board P5.

All fire-retardant solutions are CE-certified, achieved in an independently accredited fire laboratory.

The full range of CE-certified fire results can be obtained via your sales representative or by e-mailing info.panels@unilin.com.

Mezzanine Antislip

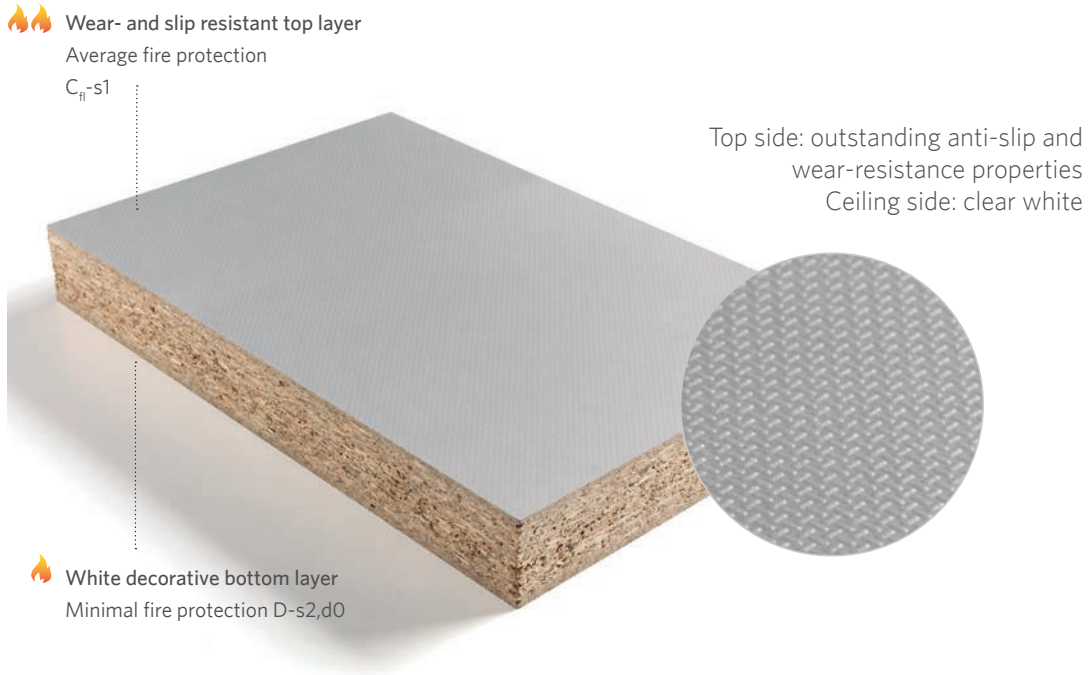

Mezzanine Antislip panels are on the top side equipped with a refreshed pressed structure for a highly slip-resistant surface, class R12. Health and safety inspectors specifically recommend using an R12 slip-resistant surface

in heavily used spaces or where oil and greasy substances are used. By giving the ceiling side a white decorative finish, light reflection is enhanced, helping to create a brighter space.

PROPERTIES



Outstanding anti-slip properties R12



Average fire-retardant top side C_{fi-s1}



Heavily used spaces



Tongue and groove on 4 sides



Wear-resistant AC4



U7 bearing capacity



A brighter space



Anti-static

FIRE-RETARDANT VERSIONS OF ANTISLIP

For fire safety, the Mezzanine Antislip can be upgraded with fire-retardant solutions to help extend evacuation time by reducing the spread of fire and limiting the development of smoke. You can find further information on fire safety on [page 10](#).

Mezzanine Supreme Antislip

B_{fi}-s1

Fitting a fire-retardant layer to the top side improves the fire reaction class from C_{fi}-s1 to B_{fi}-s1, which is the best fire reaction available for wooden floors.



Flameshield Antislip

C-CLASS

By melamine coating a white fire-retardant layer to the bottom side during the production process, the fire reaction on the ceiling side can be improved from class D to class C and the sensitivity of the product to damage during installation and transport can be reduced.

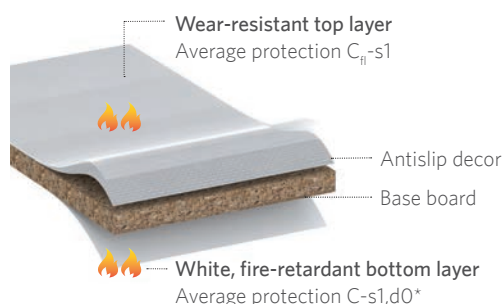

Flameshield Supreme Antislip

B-CLASS

A fire-retardant, wear-resistant top layer and a white, highly fire-retardant underlayer on the bottom side are combined to create a fire-retardant B-class mezzanine floor panel.



* Fire reaction class C-s1,d0/B-s1,d0 applicable to base boards P4 and U7, C-s2,d0/B-s2,d0 to base board P5.

All fire-retardant solutions are CE-certified, achieved in an independently accredited fire laboratory.

The full range of CE-certified fire results can be obtained via your sales representative or by e-mailing info.panels@unilin.com.

Fire safety

When a fire breaks out, every second counts. The slower the fire spreads and the smoke develops, the more time there is to limit damage and to evacuate. There are two important elements to fire safety: **fire reaction and fire resistance**.

What is fire reaction?

Many people who perish in a fire do so because of suffocation or rapid spread of the fire. The fire reaction of a product determines its contribution to these factors.

CLASSIFICATION

7 main classes according to the European standard

A1	No contribution to the spread of fire
A2	Virtually no contribution to the spread of fire
B	Flammable with very little contribution to the spread of fire
C	Flammable with little contribution to the spread of fire
D	Flammable with average contribution to the spread of fire
E	Flammable with (very) high contribution to the spread fire
F	Easy flammable, no performance requirements

Smoke intensity

s1	No or little smoke development
s2	Average smoke development
s3	Heavy smoke development

Flammable droplets/parts

d0	No droplet formation
d1	Flammable droplets formation no longer than a prescribed time
d2	Flammable droplets formation

FIRE REACTION OF THE SURFACE SIDE

The flammability of the top side and the spread of fire over the surface are measured of the Mezzanine floor panel.

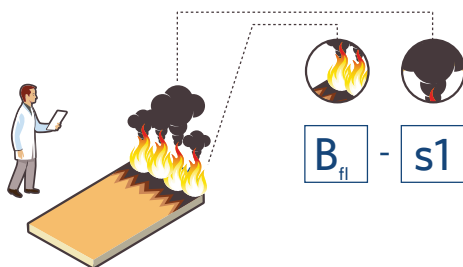

FIRE REACTION OF THE CEILING SIDE

For the ceiling or bottom side of the Mezzanine panel, the flammability is measured and the reaction in the event of an incipient fire is simulated.

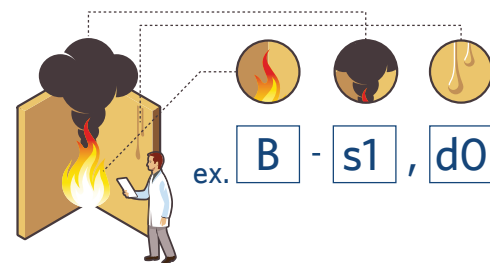

UNILIN FIRE-RETARDANT SOLUTIONS

The Mezzanine range from UNILIN comprises a series of high-quality fire-retardant floor panels. The Supreme product range improves the fire reaction on the top side, the Flameshield range improves the fire reaction on the top side and ceiling side, see pages 7-9.



What is fire resistance?

Fire resistance refers to the capacity of a construction element to retain its supporting function, integrity and/or thermal insulation for a specified time in the event of fire. The higher the fire resistance of a construction element, the better the element is capable of limiting the spread of fire to other areas.

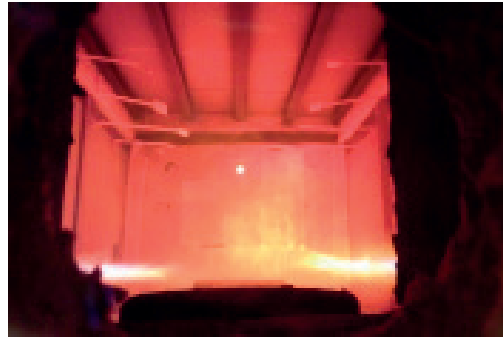

UNILIN FIRE-RESISTANCE SOLUTIONS*

Mezzanine U7 floor panels have been tested to 30 minute fire resistance (RE30, only applies in accordance with a specific floor construction*). The floor panels are installed with a tongue and groove joint, attached with bolts and supported by unprotected steel beams. In addition to the weight of the floor, an additional distributed floor load is placed on the mezzanine floor.

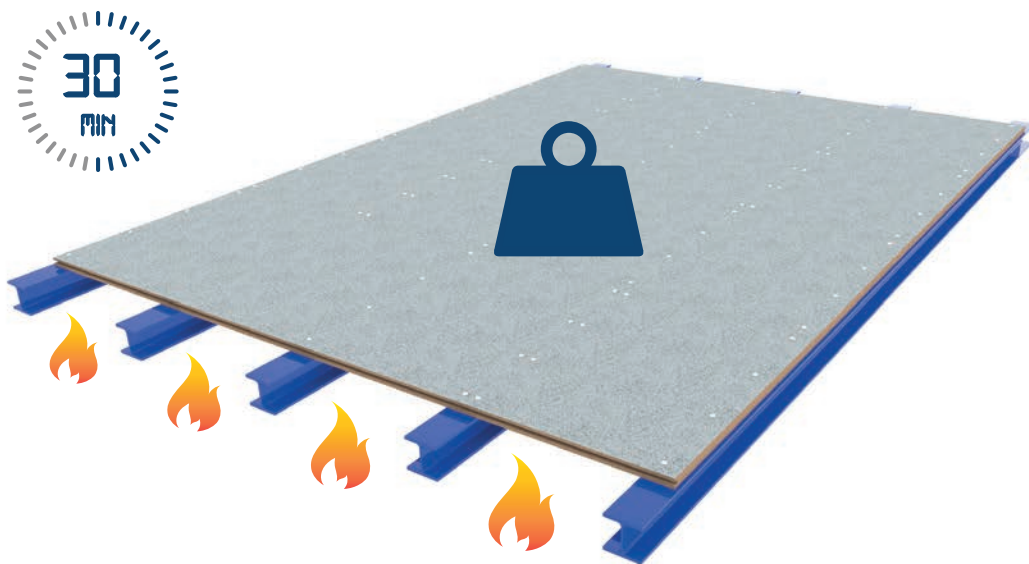

* The fire resistance achieved applies only for a specific tested floor construction. Variations in this construction do not give rise to the same result, by definition. For information concerning this setup or concerning use of this information in your project, please contact your sales representative or e-mail info.panels@unilin.com.

Load bearing capacity

The Mezzanine floor panel must be sufficiently strong to absorb all forces, distributed and point loads, whereby the floor should deflect only to a very limited extent. UNILIN has compiled indicative load tables as a support aid for architects or engineering offices.

Parameters

The following parameters have been taken into account in compiling the load tables and influence the result.

Flooring type

Mezzanine P4, P5 or U7 (P6). U7 offers the maximum possible strength and stiffness.

Spacing L (mm)

The greater the distance between the supports underneath the floor panel, the greater the deflection of the floor panel for the same load, or the lower the maximum possible load. Spacing that exceeds 1000 mm is not recommended.

Service class

A high air humidity reduces the strength and stiffness of the panels. Mezzanine P5 floor panels can be installed in humid conditions (service class 2). Mezzanine P4 and U7 are most suitable in dry conditions (service class 1).

Safety factor Ψ_2

We recommend taking into account a safety factor of $\Psi_2 = 0.8$ for storage areas in industrial environments. For storage areas in shops or meeting rooms, we apply a safety factor of $\Psi_2 = 0.6$, for residential units or offices is 0,3 used.

Load duration

The longer a load is placed on the panels, the longer the panels are under stress and the more the panels will deflect.

Deflection criterion

In specifying the maximum loading, both strength criterion and permissible deflection are tested. The maximum deflection for distributed loads is max. $L/250$ or 6mm (Eurocode 5) and for point loads max. $L/100$ or 6 mm (EN 12871).

Uniform distributed load (UDL)

A uniform distributed load is a load distributed on the floor surface. The maximum distributed load is calculated using methods outlined in the Eurocodes and panel properties, determined in accordance with EN 789 and EN 1058.



Point load (PL)

Point loads are loads that are restricted to a concentrated area, such as the stamp of racks and wheels of transport pallets.

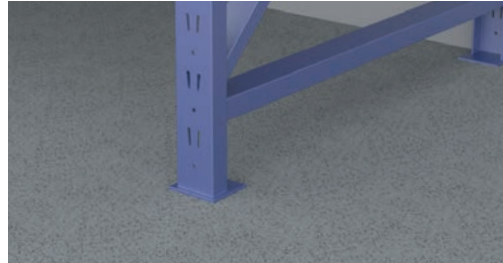

To determine the maximum point loads on Mezzanine floor panels, the panels are subjected to real-scale load testing in accordance with EN 1195.

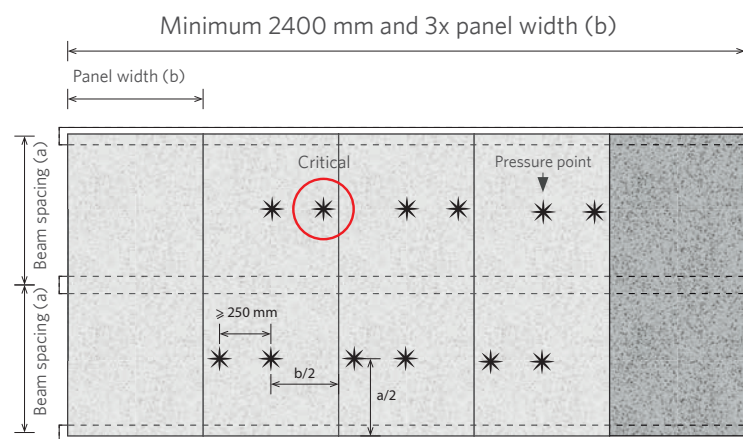

The test setup for determining the loads is in accordance with EN 1195.

The floor panels are placed on supporting beams, whereby pressure points of 50mm x 50mm (*) exert the point loads on the floor. The characteristic strength and stiffness of the floor is determined by 3 parameters.

$F_{max,k}$

The characteristic load-bearing capacity in the ultimate limit state is converted to a maximum point load at which the floor panel experiences a fracture.

$F_{ser,k}$

The characteristic load-bearing capacity in the service limit state determines the limit of the elastic region within which the maximum point load must remain.

R_{mean}

The average stiffness of the panel and the deflection criterion determine the maximum point load.

These three parameters are converted to a maximum point load for the Mezzanine floor in accordance with EN 12871, where the most critical value is retained as the maximum point load.

Mezzanine load tables

The load tables below indicate the maximum uniform distributed loads and point load for UNILIN Mezzanine floor panels. The following parameters are taken into account:

- Mezzanine floor panel with a thickness of 38 mm
- U7 is a reinforced CE-certified P6 chipboard
- Service class 1 - dry environment for P4/U7
- Service class 2 - humid environment for P5
- Maximum deflection for distributed loads: $L/250$ or max. 6 mm
- Maximum deflection for point loads: $L/100$ or max. 6 mm
- Minimum 3 spans per panel length, or 4 supports
- Maximum span: 1000 mm
- Point load stamps greater than or equal to 50mm x 50mm

Uniform distributed load (UDL)

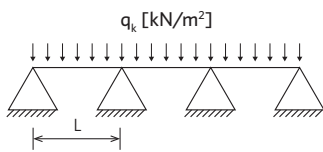

Point load (PL)

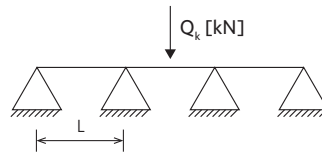

INDUSTRIAL STORAGE

- Safety factor $\psi_2 = 0.8$
- Long-term duration (6 months to 10 years)

Maximum uniform distributed load q_k (1 kN/m² \approx 100 kg/m²)

		Spacing L (mm)										
		400	425	480	500	510	525	600	750	800	850	1,000
Panel type	U7	53.9	47.7	33.5	29.6	27.9	25.5	17	8.6	7	5.8	3.4
	P5	22.8	20.2	15.8	14.5	13.8	12.6	8.4	4.1	3.4	2.7	1.6
	P4	30.8	25.6	17.7	15.6	14.7	13.5	8.9	4.4	3.6	3	1.7

Maximum point load Q_k (1 kN \approx 100 kg)

		Spacing L (mm)										
		400	425	480	500	510	525	600	750	800	850	1000
Panel type	U7	5,8	5,7	5,6	5,5	5,5	5,4	5,2	4,5	3,7	3,2	1,8
	P5	2,9	2,9	2,8	2,8	2,8	2,7	2,7	2,3	1,9	1,7	1,1
	P4	3,6	3,6	3,6	3,6	3,6	3,6	3,3	2,3	1,9	1,8	1,3

The calculations and loading tables above have been compiled on the basis of the specified calculation methods and assumptions. The studies are provided merely for the purpose of information. UNILIN, division panels, its suppliers and the person who carried out the study accept no liability for information provided by these studies. The studies do not constitute a substitute of a complete stability study by an accredited engineering offices.

CONGREGATION AND SHOPPING AREAS

- Safety factor $\Psi_2 = 0.6$
- Medium-term duration (1 week to 6 months)

Maximum uniform distributed load q_k (1 kN/m² \approx 100 kg/m²)

Panel type	Spacing L (mm)										
	400	425	480	500	510	525	600	750	800	850	1000
U7	67.3	56.0	38.8	34.3	32.3	29.6	19.7	9.9	8.1	6.7	4.0
P5	34.3	29.2	20.2	17.8	16.8	15.3	10.2	5.0	4.1	3.3	1.9
P4	36.7	30.5	21.1	18.6	17.5	16.0	10.6	5.3	4.3	3.5	2.0

Maximum point load Q_k (1 kN \approx 100 kg)

Panel type	Spacing L (mm)										
	400	425	480	500	510	525	600	750	800	850	1000
U7	7,2	7,2	7,2	7,2	7,2	7,1	6,7	5,4	4,6	3,8	2,1
P5	4,0	4,0	4,0	4,0	4,0	4,0	3,6	2,8	2,3	2,0	1,4
P4	4,3	4,3	4,3	4,3	4,3	4,3	4,0	2,7	2,3	2,1	1,5

RESIDENTIAL AND OFFICE AREAS

- Safety factor $\Psi_2 = 0.3$
- Medium-term duration (1 week to 6 months)

Maximum uniform distributed load q_k (1 kN/m² \approx 100 kg/m²)

Panel type	Spacing L (mm)										
	400	425	480	500	510	525	600	750	800	850	1000
U7	75.6	66.9	50.8	44.9	42.3	38.7	25.8	13.0	10.6	8.8	5.2
P5	34.3	30.4	23.8	21.9	21.0	19.8	15.0	7.4	6.0	4.9	2.8
P4	44.9	39.8	29.6	26.1	24.6	22.5	14.9	7.4	6.0	4.9	2.8

Maximum point load Q_k (1 kN \approx 100 kg)

Panel type	Spacing L (mm)										
	400	425	480	500	510	525	600	750	800	850	1000
U7	8,1	8,0	7,8	7,7	7,7	7,6	7,2	6,6	5,3	4,6	2,7
P5	4,4	4,3	4,2	4,1	4,1	4,1	4,0	3,8	3,3	3,0	2,0
P4	5,6	5,6	5,5	5,5	5,4	5,4	5,1	3,9	3,2	3,0	2,2

The calculations and loading tables above have been compiled on the basis of the specified calculation methods and assumptions. The studies are provided merely for the purpose of information. UNILIN, division panels, its suppliers and the person who carried out the study accept no liability for information provided by these studies. The studies do not constitute a substitute of a complete stability study by an accredited engineering offices.



Tongue and groove profile

The Mezzanine range is available with **tongue and groove profile type F** on four sides. In addition to increased strength, this conical profile has a number of innovative properties:

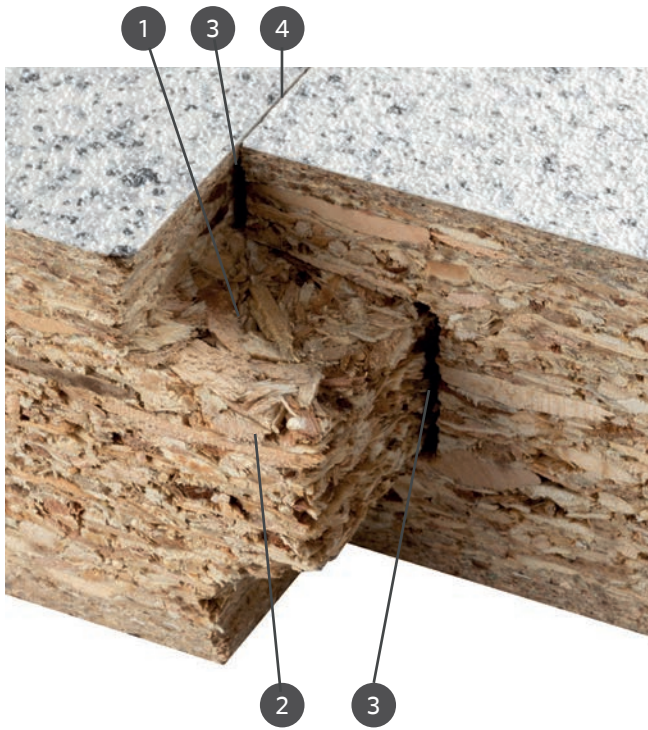

- 1 Large bearing surface for increased load bearing capacity.
- 2 Conical profile for fast and easy installation.
- 3 Dust chambers help to create a connecting joint.
- 4 Reduced stepping and a closed joint limit damage during use.

Distributed by





Technical manual

General

The mezzanine panels can be installed to create a complete floor surface, **mezzanine floor** or intermediate floor suitable for the storage and transport of goods. Hand pallet trucks for transport should ideally be equipped with a dual steering wheel and double tandem wheels to help distribute the load, reduce point friction and minimise wheel wear. If laminated floor panels (Deluxe and Antislip) are installed, we recommend the use of **soft wheels** instead of hard polyamide wheels. The stamp of racks must have minimum dimensions of 50 mm x 50 mm. Larger dimensions are better at distributing the load.

A **leveled supporting steel structure** is required to ensure a leveled basis for the floor panels and to rule out differences in height between the individual panels. This difference in height, referred to as 'stepping', can give rise to erosion or damage to the surface of the floor.

- | | |
|--------------------|----------------------------|
| 1 Column | 6 Mezzanine floor panel |
| 2 Secondary beam | 7 Uniform distributed load |
| 3 Main beam | 8 Point load |
| 4 Buckling support | 9 Transport material |
| 5 Bracing | |

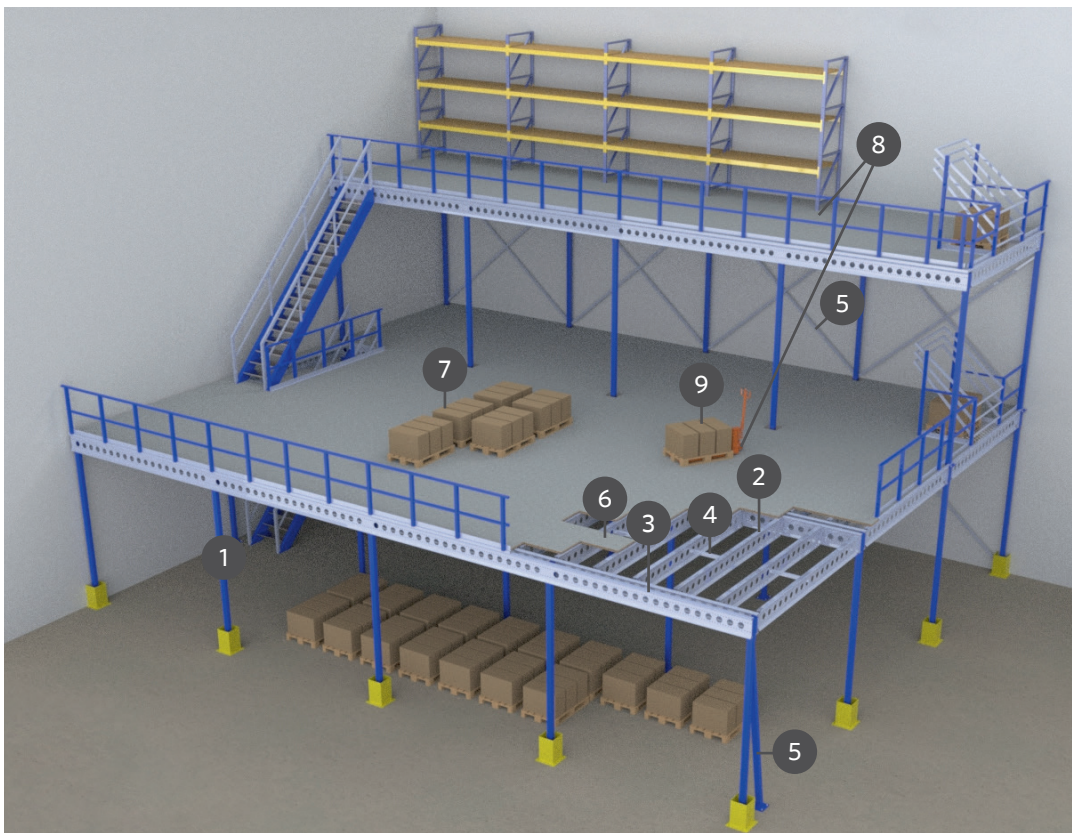

The illustrations used in the technical manual are for information purposes only and in no way constitute structural detail for design or stability studies of a Mezzanine floor. Structural details are developed by the project architect or engineering offices.

Floor construction

The floor panels are placed perpendicular to the direction of the beams with the joints of the short panel sides staggered between laterally adjacent panels. The short panel side must always be supported by a beam in order to ensure the maximum bearing force of the floor system.

Each floor panel is supported by at least 4 support beams ❶. Reducing the number of support beams can have an impact on the maximum permissible load. This number can be reduced to 3 support points along the edges of the floor surface where cut pieces are used to finish.

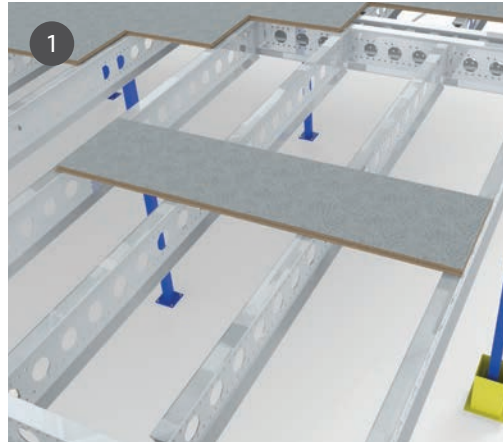

The floor panels transfer the load to the secondary beams, which in turn transfer the load to the main beams ❷ ❸.

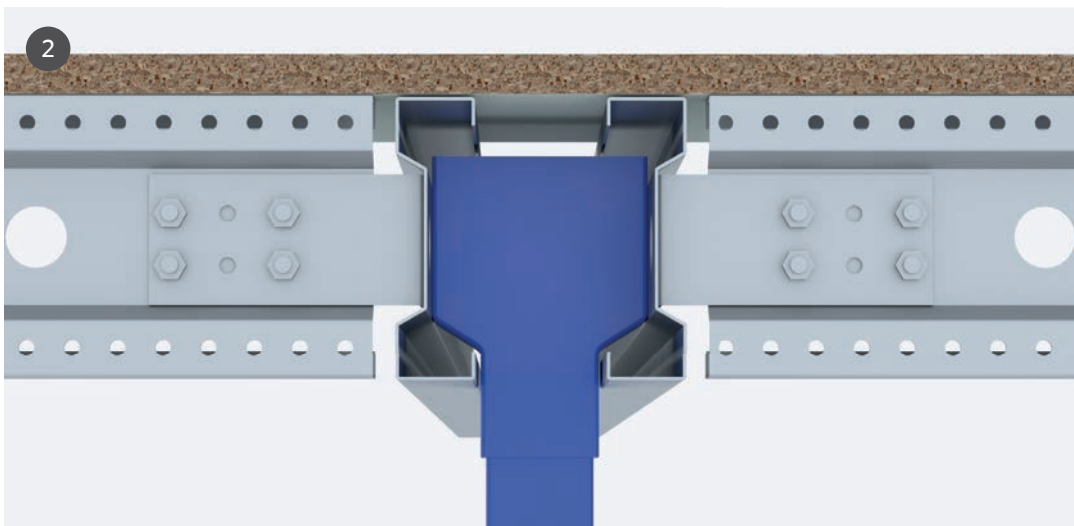

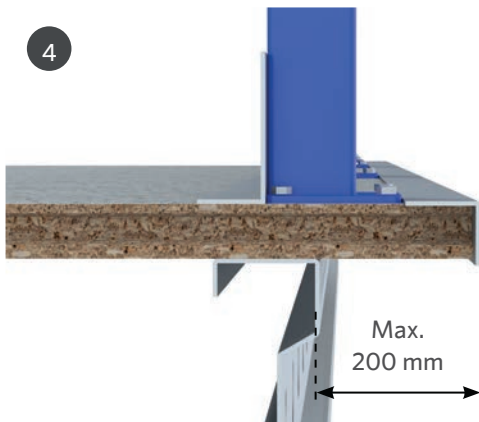

The edge zone of the floor must be supported by the underlying steel structure. Loaded cantilevers are strongly discouraged and may protrude from the bearing structure by a maximum of 200 mm ⁴.

The edges of the floor area are often finished with a bumper and handrail attached to the panels. A metal lip is often installed on the edge around the perimeter of the mezzanine floor surface ⁵.

In heavily used areas like loading zones or high traffic zones, the Mezzanine floor panel may be protected with, for example, a diamond plate ⁶.

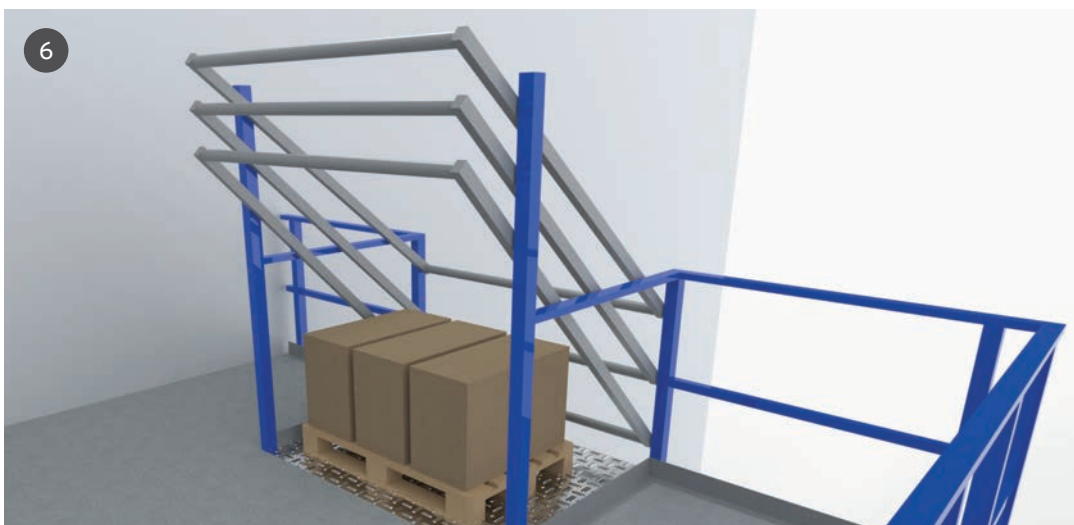
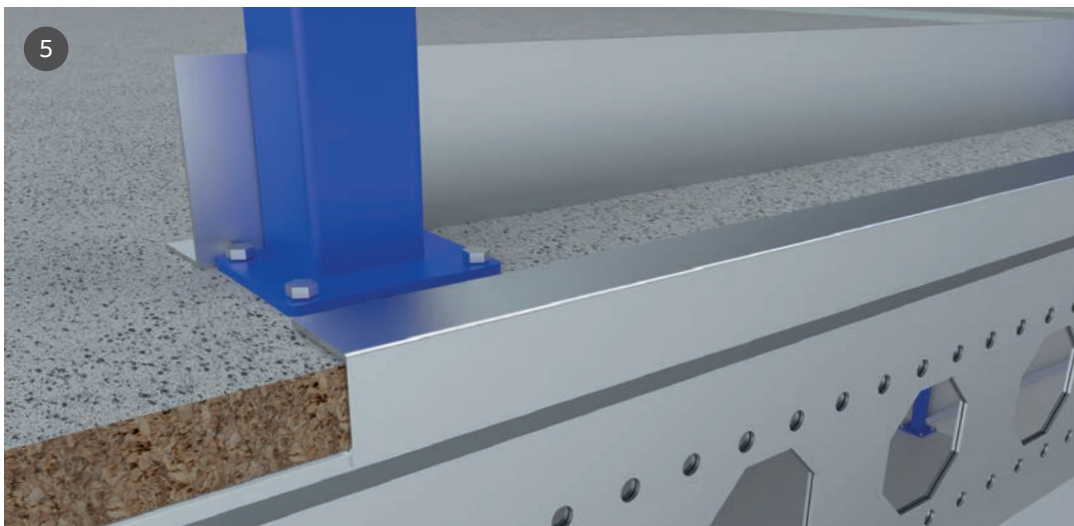

Fasteners

Screws

The Mezzanine floor panels are attached to the metal structure with screws. The fastener that is most suitable for your project should be determined in consultation with the engineering office and the producer of the fastener.



The following parameters may play a role in selecting the correct screw:

- A self-drilling screw is most suitable so that pre-drilling and threading of the screw occurs in a single movement. The point of the screw will always pre-drill at the right diameter.
- A self-tapping screw is most suitable so that the screw thread can tap into the sheet steel and secure the attachment.
- The length of the screw is determined according to the thickness of the floor panel, the sheet steel and the drilling point. The drilling point should ideally pierce 2 to 3 screw threads past the sheet steel. For example: the combination of a 38 mm Mezzanine panel, 3 mm sheet steel, a drilling point of 23 mm and 1 mm screw thread gives a screw length of 65 mm.
- Wing teks or wing pias on screws are recommended so that the wood is made slightly larger than the screw. This allows the wood to expand and shrink without exerting any tension on the screw.
- A screw thread with milling ribs or dips ensures that the head is properly leveled into the wood for a neat surface finish.
- A screw head with a torx or AW drive transfers a higher torque to the screw without damaging the bit or the screw itself. This helps to extend the service life of the screw and simplify installation.
- A screw thread with 'cutting grooves' removes the superfluous sheet material so that the screw is less likely to jam.
- A rustproof A2 coating is the most universal coating with exceptional corrosion resistance under normal atmospheric conditions. An A4 coating helps to increase resistance against pitting in aggressive environments such as coastal locations and industrial areas. A Ruspert coating reduces the effect of cold welding and helps to increase resistance to weather.



Example screws:
Wurth - ZEBRA wing pias BS
Diameter: 6.3 mm
Length: 70 mm

Tongue and groove adhesive

We recommend using adhesive in the tongue and groove joint. This helps to increase the overall resistance of the floor and to limit vibration and cracking as a result of expansion. In addition, an adhesive joint can help to minimise stepping if the substructure is uneven. The most suitable adhesives are PVAc adhesive (type D4, waterproof white wood glue) or PU adhesive.



Example adhesive:
Würth RAPID PUR CONSTRUCT FIX.



Installation

The panels are slid together during installation. If attachments are being used, take care not to use anything that could damage the surface finish or tongue and groove joints.

Mezzanine floor panels are typically attached to the substructure from above **1** **2**. If you do not wish to puncture the surface, you can attach the panels from the bottom side with the support beams and floor panel pre-drilled before screwing.

The screws must be countersunk to prevent damage.

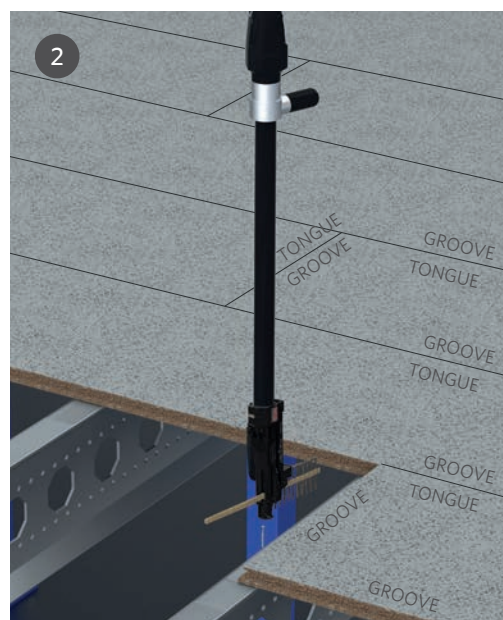

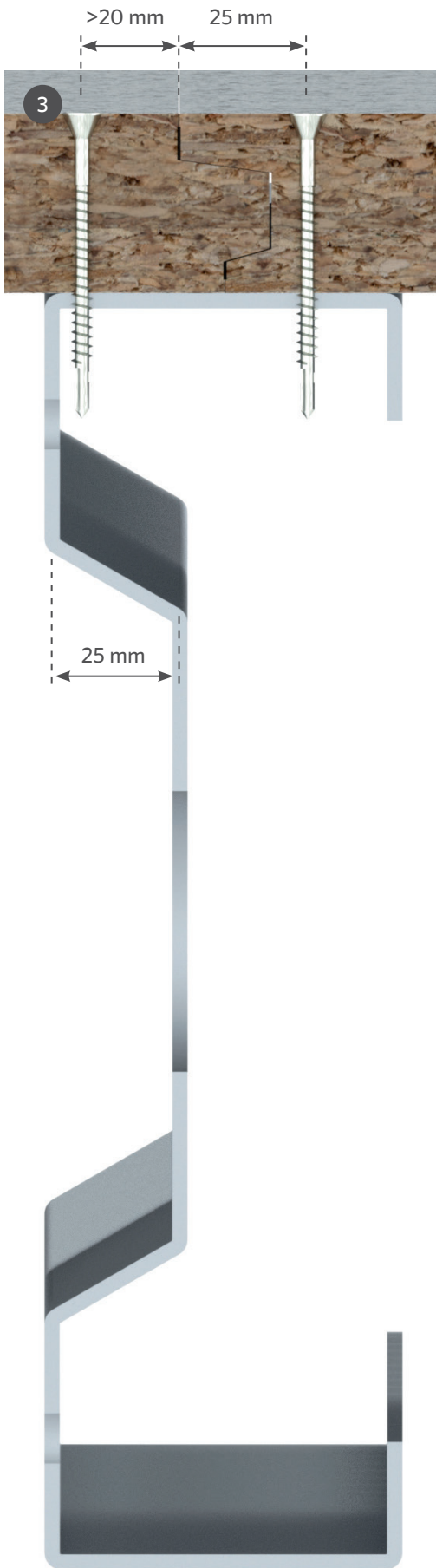

The screws are placed a minimum of 20 mm from the tongue edge and 25 mm from the groove edge ③ and with a straight edge, a minimum of 15 mm. The tongue and groove joint should ideally lie flat above the web of the beam. In the event that the joint edges too far towards the open side, the flange of the beam will deflect more quickly in the event of a load on the grooved edge, which will cause stepping more quickly.

For panel widths of 600 mm and 850 mm, a minimum of 3 attachment points is recommended per cross beam ④ and a minimum of 4 attachment points for a panel width of 1000 mm ⑤.

The number of attachment points can be reduced for intermediate crossbeams ⑥.

④ Screw pattern for panel widths of 600 mm and 850 mm

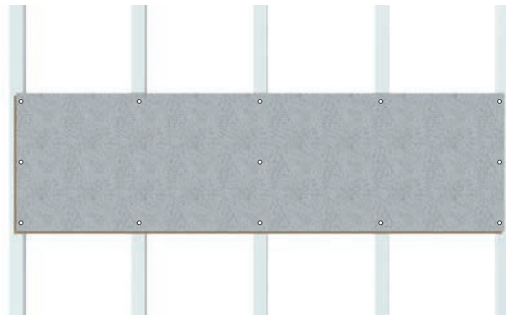

⑤ Screw pattern for panel width of 1,000 mm

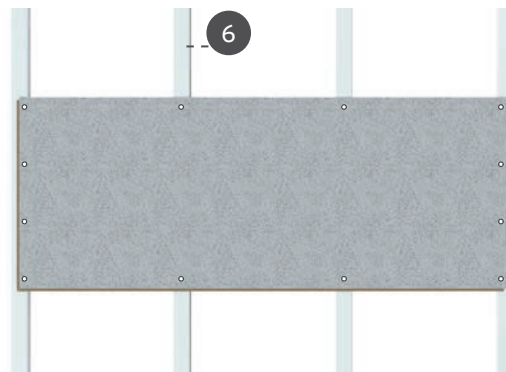



Wooden floor panels may expand or shrink in changing temperatures and humidity. This dimensional change can be absorbed by expansion joints.

Mezzanine floor panels are installed separately from the production hall with a minimum 80 mm distance so that the largest expansions can be absorbed at the periphery **7**. In addition, expansion joints must also be installed at columns or other objects that prevent a continuous floor **8**.

Where one side of a floor surface is longer than 10 m, it is advisable to install an additional expansion joint of 10 mm every 10 m, as recommended in the standard DTU 51.3 and CEN TS 12872. This joint must be protected to prevent damage. When installing additional expansion joints, support must be ensured by, for example, installing an additional support beam.

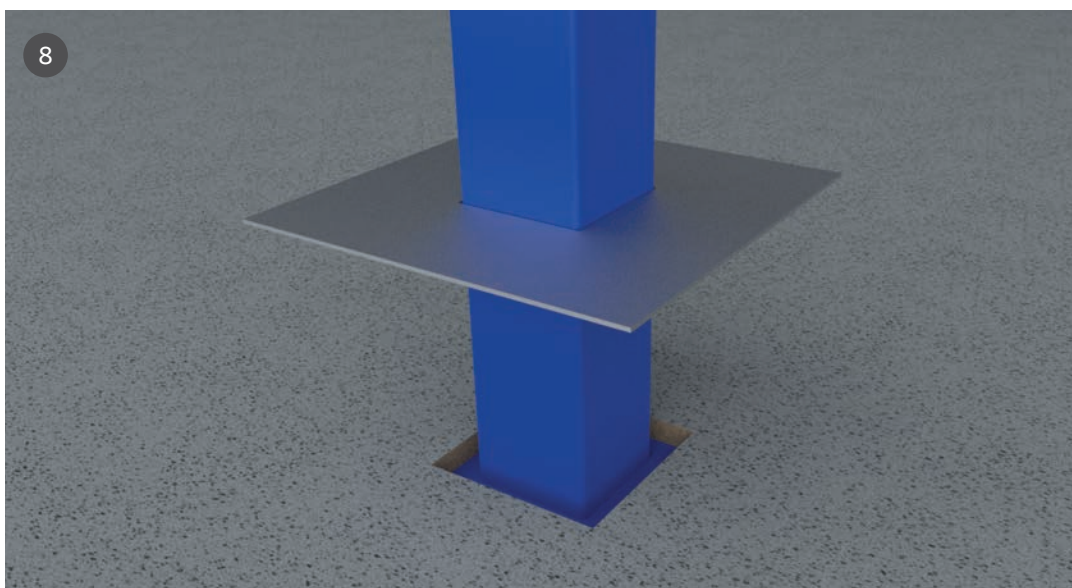
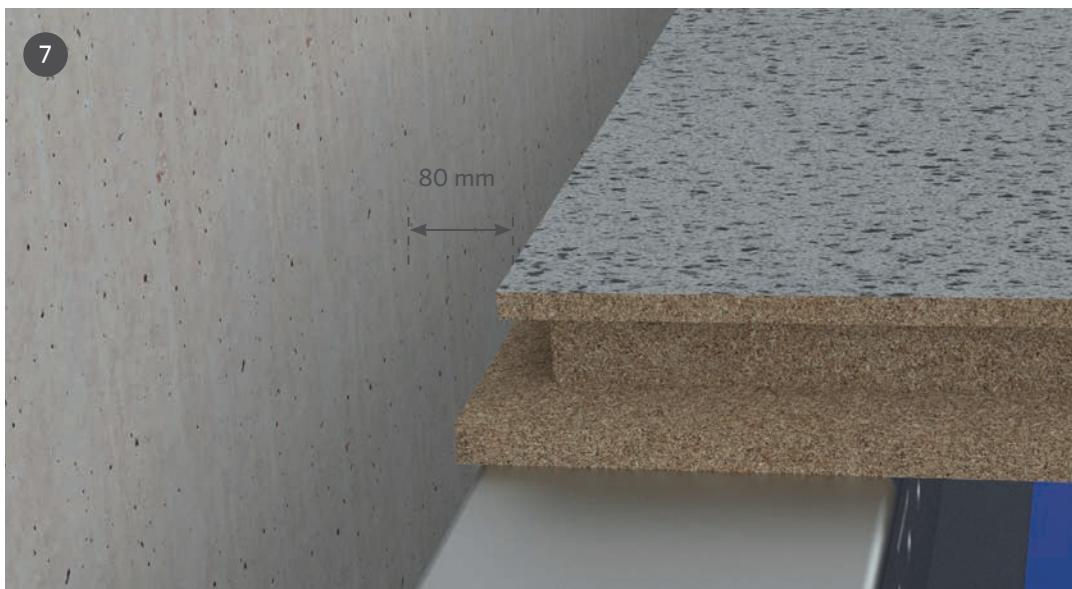

Walkways

Mezzanine floor panels can also be installed in walkways, where the long side must be fully supported by support beams. In this case, support on the short edges is not required.

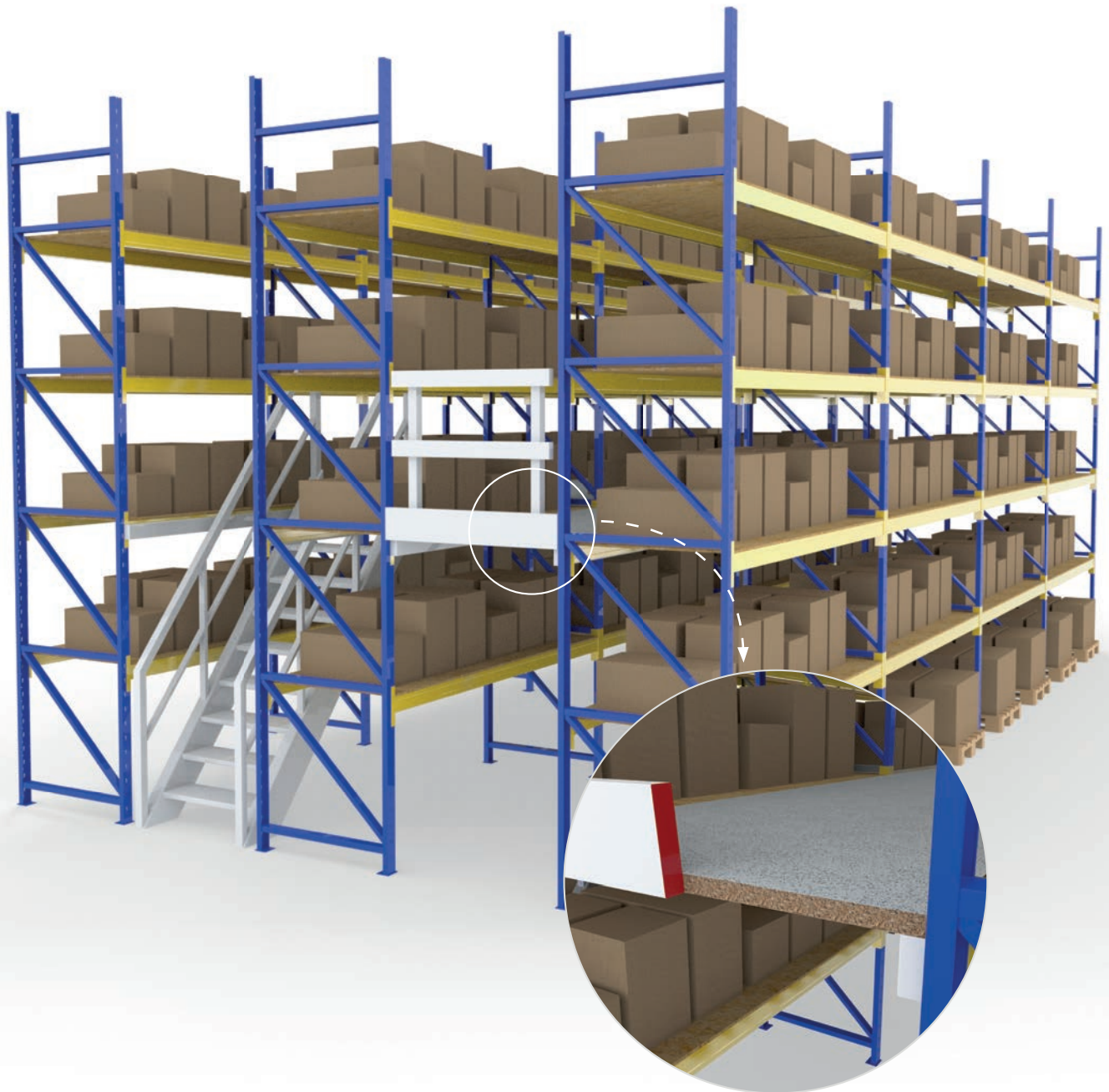

General conditions and storage

Mezzanine panels are stacked horizontally in packages and should be stored in a dry environment. Direct contact with the ground floor must be avoided by using supporting blocks or pallets. If there is a risk of damp ground, a water-tight film must be laid over the ground before the packages are stacked. The storage area must be dry and well ventilated.

We recommend having the floor panels delivered to the site at least a week before installation so that the panels can adapt to

the environment. In that case, the storage conditions should be harmonised with the final application of the panels. Where there is a risk of higher humidity (e.g. in cement plants), work should be postponed until the correct conditions prevail. High air humidity can lead to a decrease in the strength and stiffness of the panels.

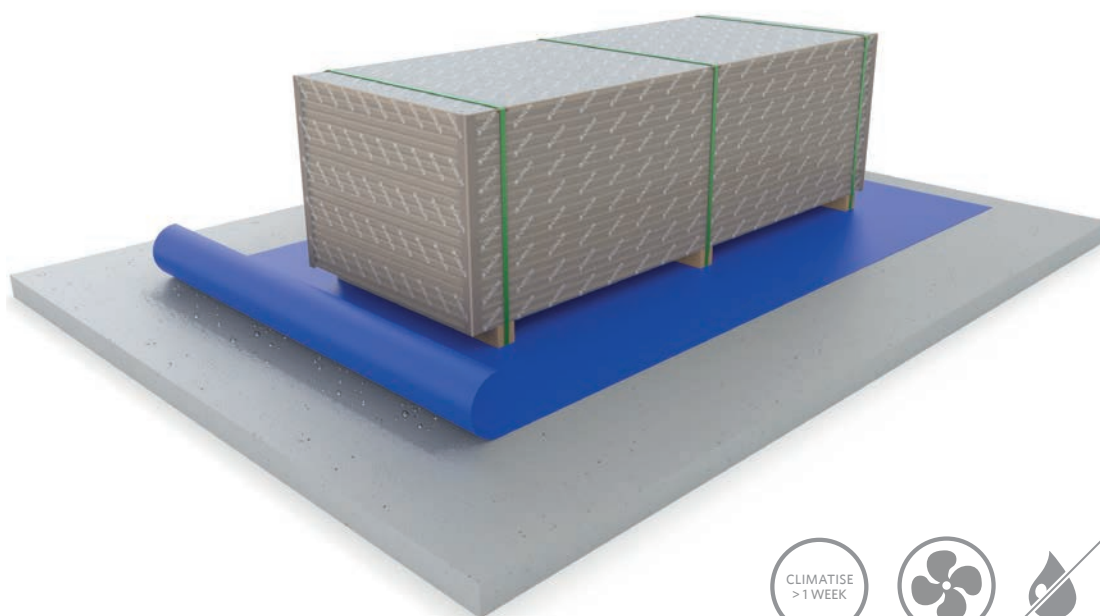

Climate class

	Relative humidity range at 20°C	Average equilibrium moisture content in the panel	Panel material type	Application
Climate class 1 (dry environment)	30 - 65%	4 - 11%	P4/P6/U7	Structural application in dry environment
Climate class 2 (humid environment)	65 - 85%	11 - 17%	P5	Structural application in humid environment
Climate class 3 (wet environment)	>85%	>17%	/	Direct contact with water possible

Finish and maintenance

Mezzanine floors with an unfinished surface (e.g. Standard and White) may be sanded to prepare the surface for later finishing. While sanding, ensure that proper dust extraction is in place and remove all remaining dust particles afterwards. The floors can be cleaned with a brush, compressed air or a damp cloth. Direct industrial cleaning with water is discouraged on wooden floors without a closed surface finish and with welded seams.

If the panels have already been installed, damage to the surface can be repaired with a standard elastomer kit, such as Tec7 or wood paste. If the panels are still to be installed, they can firstly be repaired with PU D4 adhesive. Superfluous adhesive should be cut off after installation.

Distributed by  **unistor**



Stock range

Distributed by 

Ergonomic sizing

A broad range of Mezzanine U7 panels is available in stock for immediate delivery.

	Dimensions (mm x mm)	Pieces (per pack)	Optimal spacing between supports (mm)									
			400	425	480	500	510	525	600	750	800	850
Mezzanine U7 Standard TG 38 mm - 4 sides TG	600 x 2400	50	•		•					•		•
	1000 x 2550	22		•				•				•
Mezzanine U7 White TG 38 mm - 4 sides TG	600 x 2400	50	•		•					•		•
	1000 x 2550	22		•				•				•
	850 x 3000	22				•		•	•	•		
Mezzanine U7 Deluxe TG 38 mm - 4 sides TG	600 x 2400	50	•		•					•		•
	1000 x 2550	22		•				•				•
Mezzanine U7 Antislip TG 38 mm - 4 sides TG	600 x 2400	50	•		•					•		•
	1000 x 2550	22		•				•				•



UNILIN, division panels

UNILIN, division panels, part of the UNILIN group, has been supplying innovative wood solutions for construction and interior projects since 1960. Our chipboard, MDF, HDF, HPL and melamine panels find their way into commercial outlets in wood and building materials, industrial installers and DIY chains worldwide.

We develop solutions tailored to your needs with creativity as our engine and innovation as our driving force. In addition, we continuously invest in product design and new technologies. That makes us a leading international player today, and a lasting partner in our industry.

Our 1,300 employees give their best every day in our production facilities in Belgium and France. Together we produce 2.1 million m³ of panel material every year.



Ingelmunstersteenweg 229, 8780
Oostrozebeke - Belgium T +32 56 66 70 21 - F
+32 56 66 82 25 info.panels@unilin.com -
www.unilinpanels.com



Unistor Global Pty Ltd
1300 137 220
sales@unistor.com.au
www.unistor.com.au